



Copa A de Espana Absoluta Marin 2022

Marin (GAL), 02 Apr 2022

-66 kg

24 Judoka

POOL A

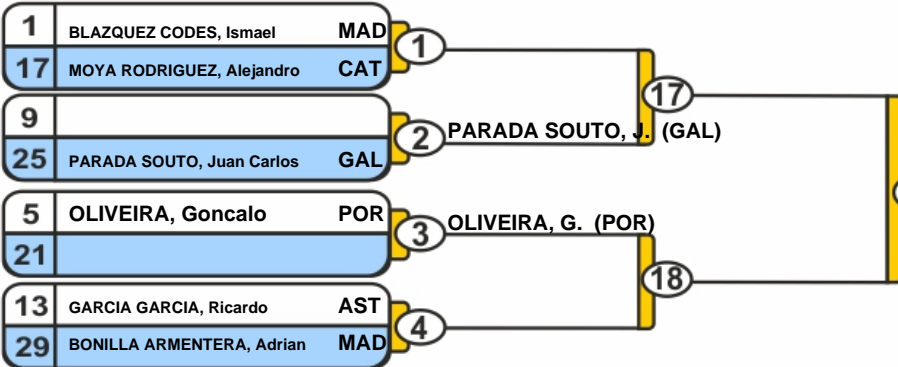

POOL B

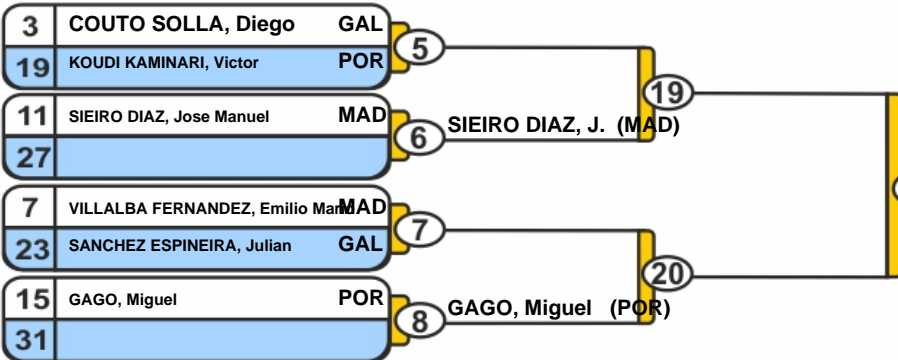

POOL C

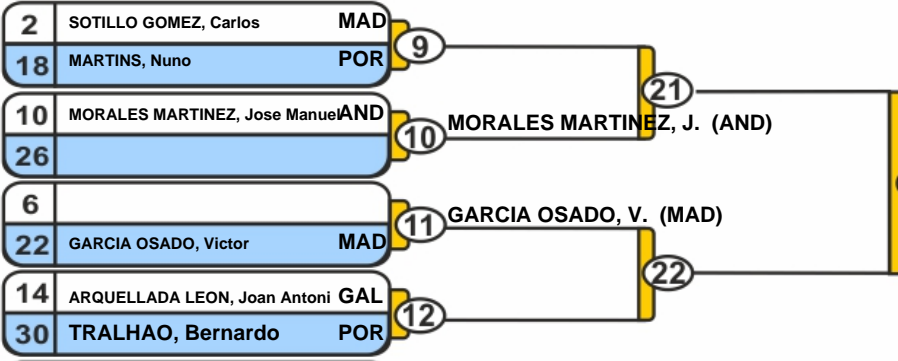

POOL D

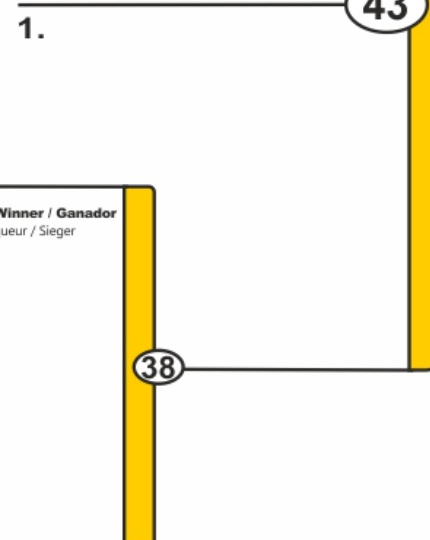
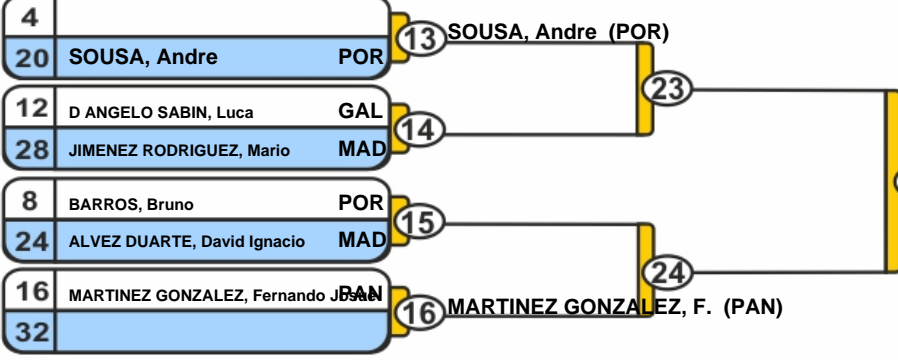

Trostrunde / Repechage / Ronda de consolación

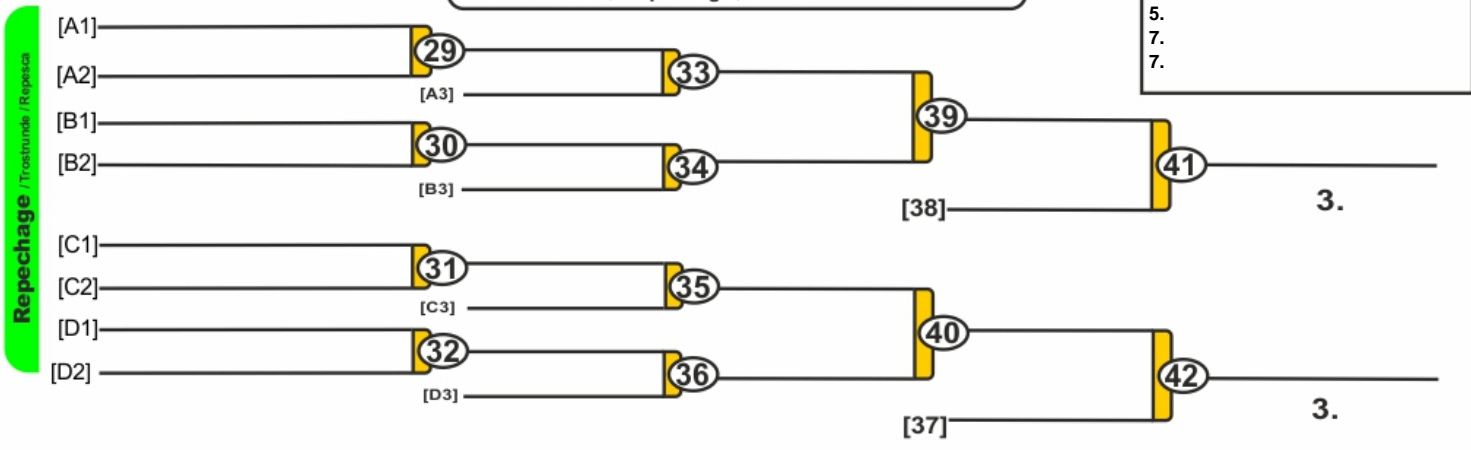

Results	
Résultat / Platzierungen / Resultados	
1.	
2.	
3.	
3.	
5.	
5.	
7.	
7.	



Copa A de Espana Absoluta Marin 2022

Marin (GAL), 02 Apr 2022

-73 kg

34 Judoka

POOL A

1	LEIROS DIAZ, Dimas GAL
33	CANO MARTOS, Sergio AND
17	DANELIA, Saba POR
49	GONZALEZ GONZALEZ, Ronal PAN
9	PONCE CANALES, Ruben MAD
41	GONZALEZ GONZALEZ, Pelayo AST
25	PEREZ FERREIRO, Pablo Miguel GAL
57	GOMES, Thelmo POR
21	GRACIA GARIJO, Ibai NAV

2	CANO MARTOS, Sergio
3	DANELIA, Saba
4	GONZALEZ GONZALEZ, Ronal
5	PONCE CANALES, Ruben
6	GONZALEZ GONZALEZ, Pelayo
7	PEREZ FERREIRO, Pablo Miguel
8	GOMES, Thelmo

POOL B

3	MACALOU SOUCKO, Moussa ARA
35	FARO NORES, Iago GAL
19	PAZOS PLANELLS, Sergio BAL
51	BARTOLOME PELAYO, Pablo CLE
11	HERNANDEZ MORALES, Diego CAN
43	GOMES, Tomas POR
27	CUPEIRO DOMINGO, Jorge GAL
59	TUTUNAROV, Yoan NOR

9	MACALOU SOUCKO, Moussa
10	FARO NORES, Iago
11	PAZOS PLANELLS, Sergio
12	BARTOLOME PELAYO, Pablo
13	HERNANDEZ MORALES, Diego
14	GOMES, Tomas
15	CUPEIRO DOMINGO, Jorge
16	TUTUNAROV, Yoan

POOL C

2	FARO NORES, Alexandre GAL
34	BEZERRA, Nievisson POR
18	RUBIO GUTIERREZ, Gonzalo MAD
50	KWIERS HARRIS, Arturo Edgardo PAN
10	GOIKOETXEA ALONSO, Aitor VAL
42	PAVON DE LA CRUZ, Jorge BAL
26	PEREZ COLLAZO, Alberto RIO
58	XARGA ANGLADA, Eduard CAT
6	TORRADO SANMARTIN, Carlos GAL

17	FARO NORES, Alexandre
18	BEZERRA, Nievisson
19	KWIERS HARRIS, Arturo Edgardo
20	GOIKOETXEA ALONSO, Aitor
21	PAVON DE LA CRUZ, Jorge
22	PEREZ COLLAZO, Alberto
23	XARGA ANGLADA, Eduard
24	TORRADO SANMARTIN, Carlos

POOL D

4	IBANEZ BANON, Sergio ARA
36	GONZALEZ MIGUELEZ, Alejandro AND
20	IGLESIAS ALVAREZ, Alejandro GAL
52	KVANTIDZE, Otari POR
12	ROQUE ARENCIBIA, Eftren CAN
44	CRISOSTOMO, Joao POR
28	GESTAL QUEIJAS, Alejandro GAL
60	RODRIGUEZ PEREZ, Ruben De La Caridad MAD
8	
40	
24	
56	
16	
48	
32	
64	

25	IBANEZ BANON, Sergio
26	GONZALEZ MIGUELEZ, Alejandro
27	IGLESIAS ALVAREZ, Alejandro
28	KVANTIDZE, Otari
29	ROQUE ARENCIBIA, Eftren
30	CRISOSTOMO, Joao
31	GESTAL QUEIJAS, Alejandro
32	RODRIGUEZ PEREZ, Ruben De La Caridad

Repechage

Trostrunde / Repechage / Ronda de consolación

[A1]	
[A2]	61
[B1]	
[B2]	62
[C1]	
[C2]	63
[D1]	
[D2]	64

[A3]	65
[A4]	69
[B3]	66
[B4]	70
[C3]	67
[C4]	71
[D3]	68
[D4]	72

Results
Résultat / Platzierungen / Resultados

-
-
-
-
-
-
-





Copa A de Espana Absoluta Marin 2022

Marin (GAL), 02 Apr 2022

-81 kg

24 Judoka

POOL A

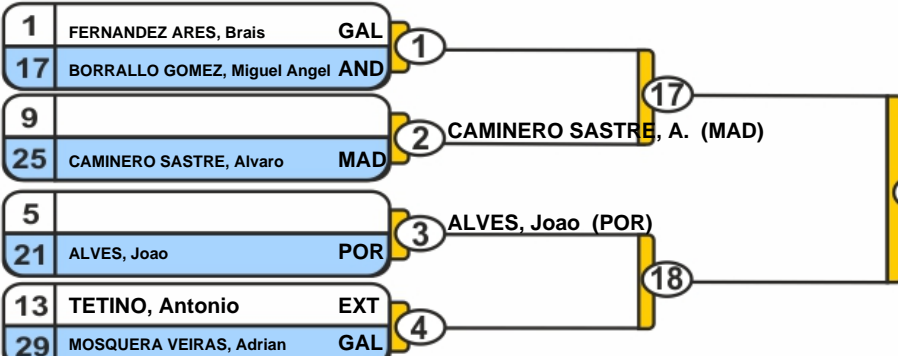

POOL A Winner / Ganador
Vainqueur / Sieger

POOL B

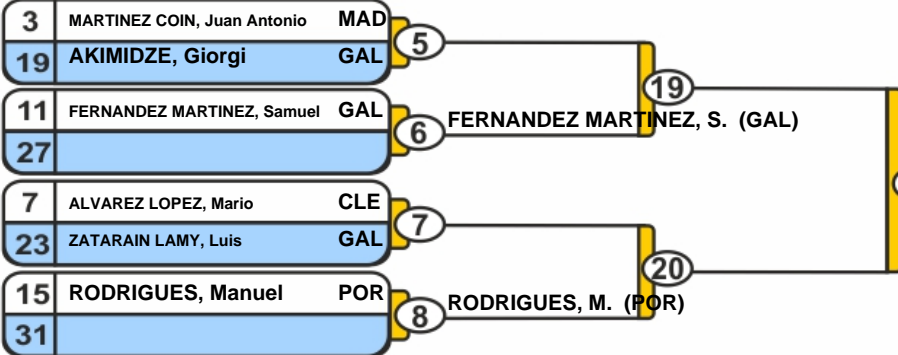

POOL B Winner / Ganador
Vainqueur / Sieger

POOL C

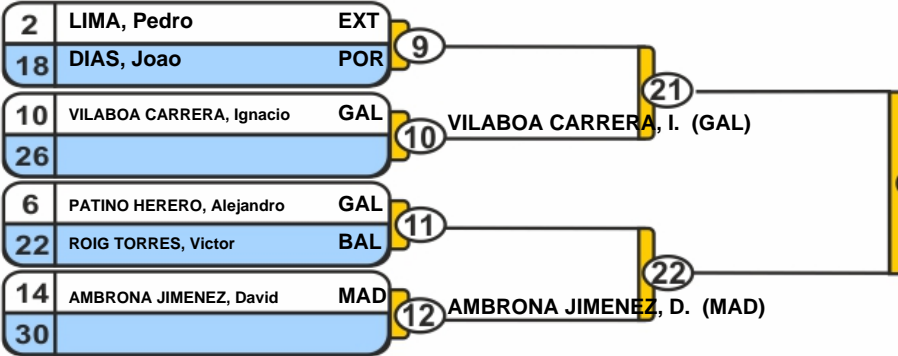

POOL C Winner / Ganador
Vainqueur / Sieger

POOL D

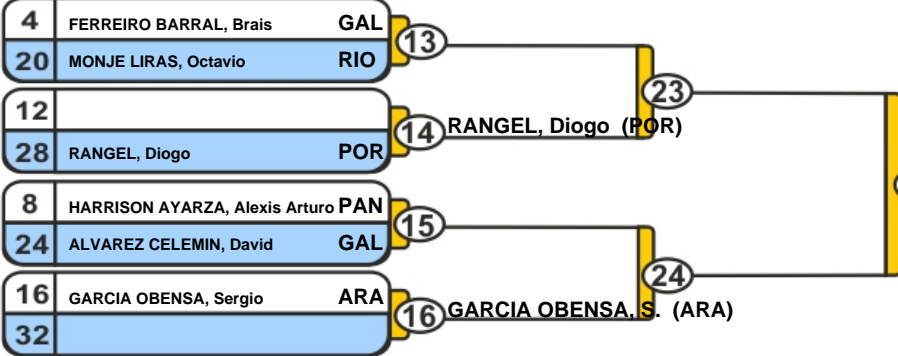

POOL D Winner / Ganador
Vainqueur / Sieger

1.

Results	
Résultat / Platzierungen / Resultados	
1.	
2.	
3.	
3.	
5.	
5.	
7.	
7.	

Trostrunde / Repechage / Ronda de consolación

Repechage / Trostrunde / Repechage





Copa A de Espana Absoluta Marin 2022

Marin (GAL), 02 Apr 2022

-90 kg

16 Judoka

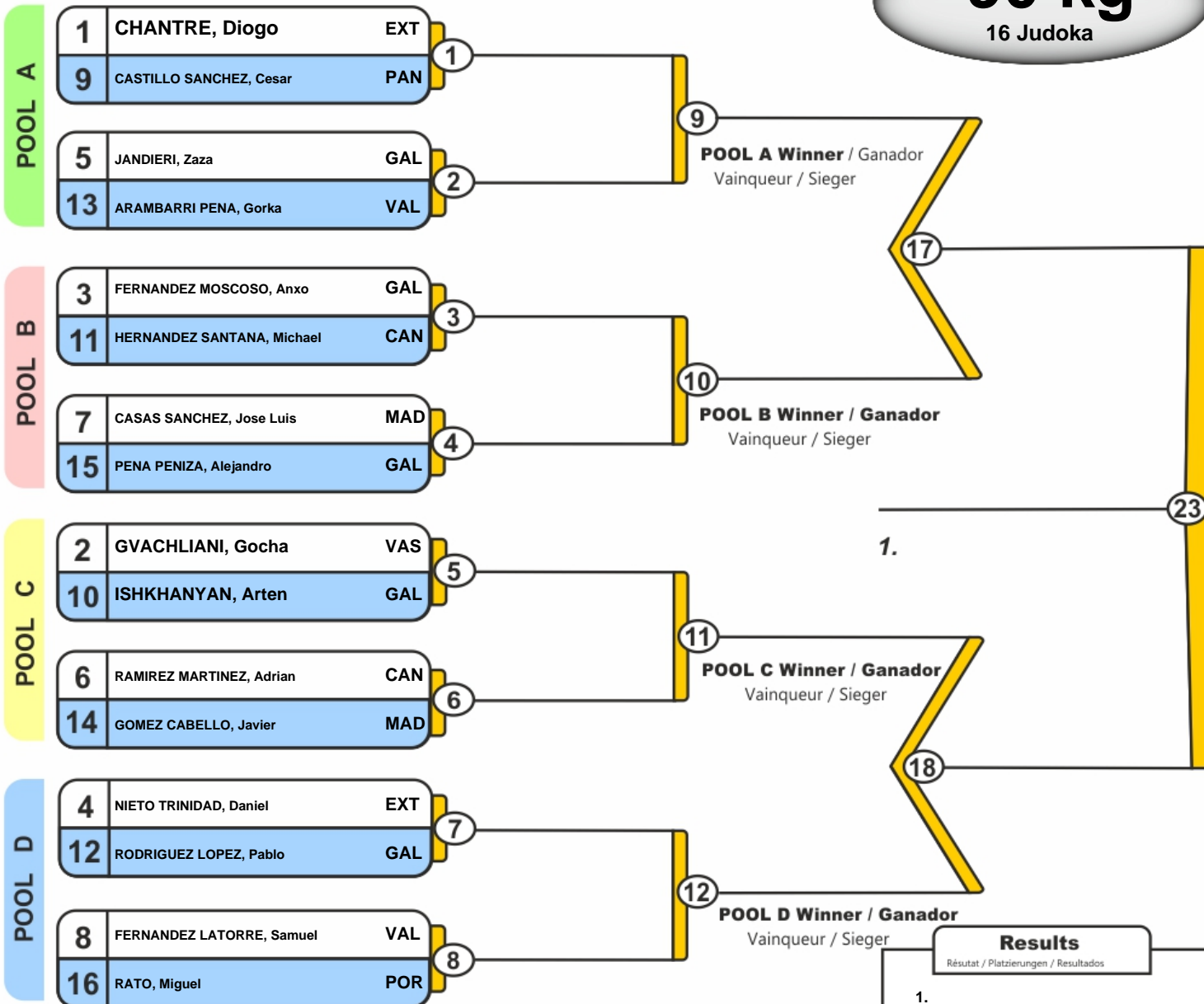

Trostrunde / Repechage / Ronda de consolación

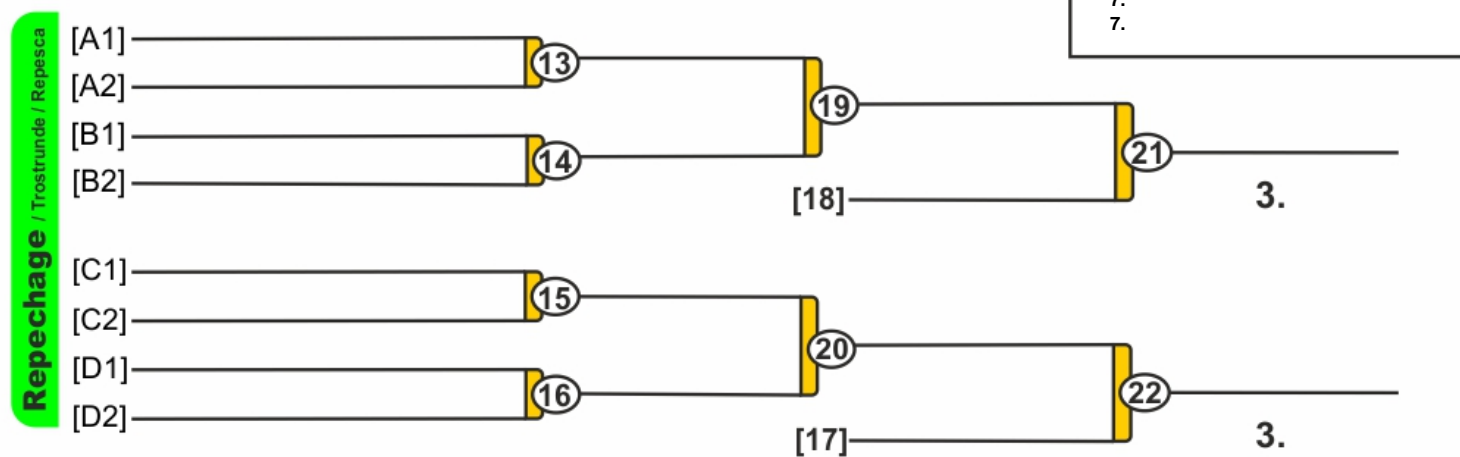

Results	
Résultat / Platzierungen / Resultados	
1.	
2.	
3.	
3.	
5.	
7.	
7.	



Copa A de Espana Absoluta Marin 2022

Marin (GAL), 02 Apr 2022

-100 kg

9 Judoka

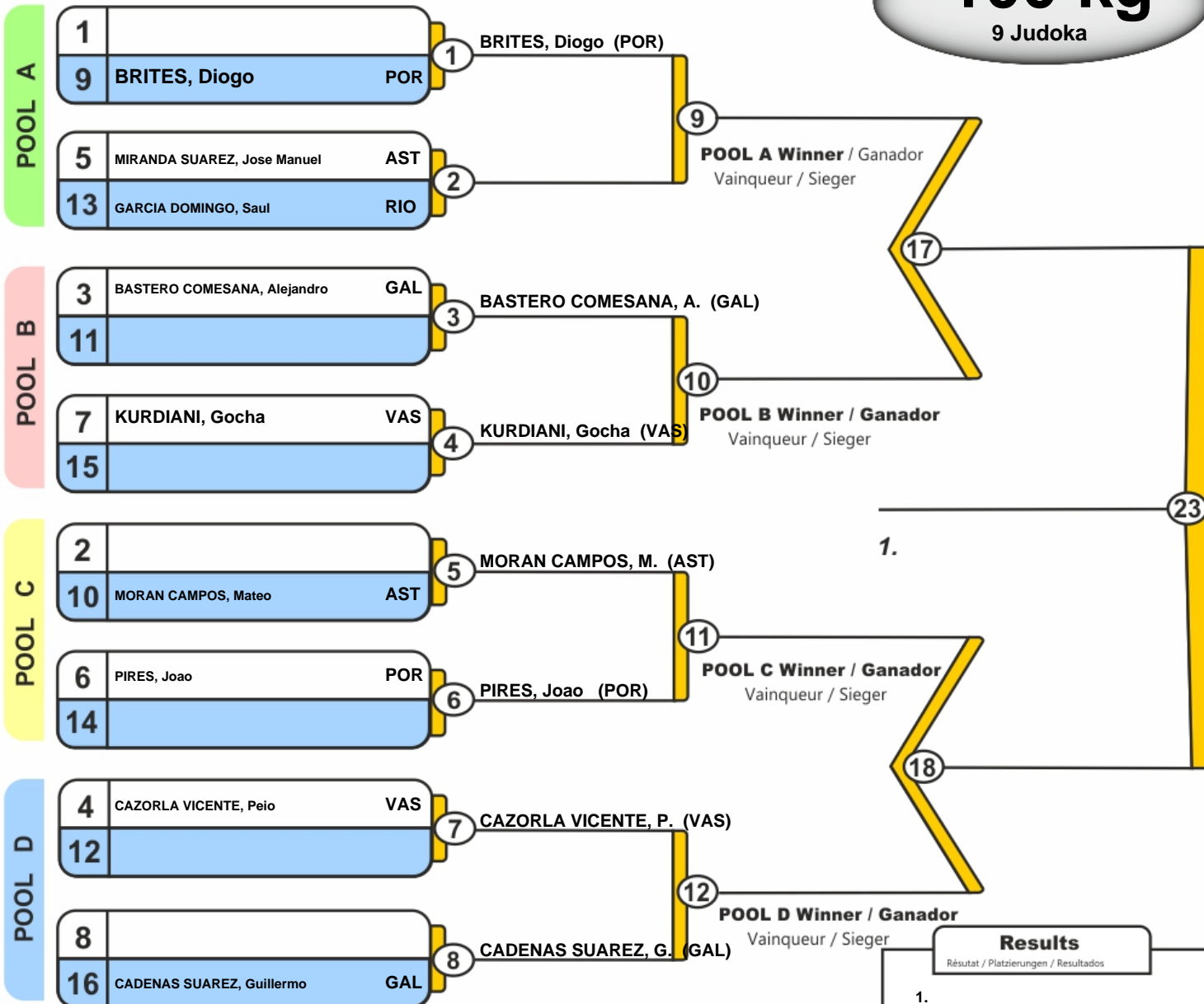

1.

POOL C Winner / Ganador
Vainqueur / Sieger

POOL D Winner / Ganador
Vainqueur / Sieger

Results

Résultat / Platzierungen / Resultados

- 1.
- 2.
- 3.
- 3.
- 5.
- 7.
- 7.

Trostrunde / Repechage / Ronda de consolación

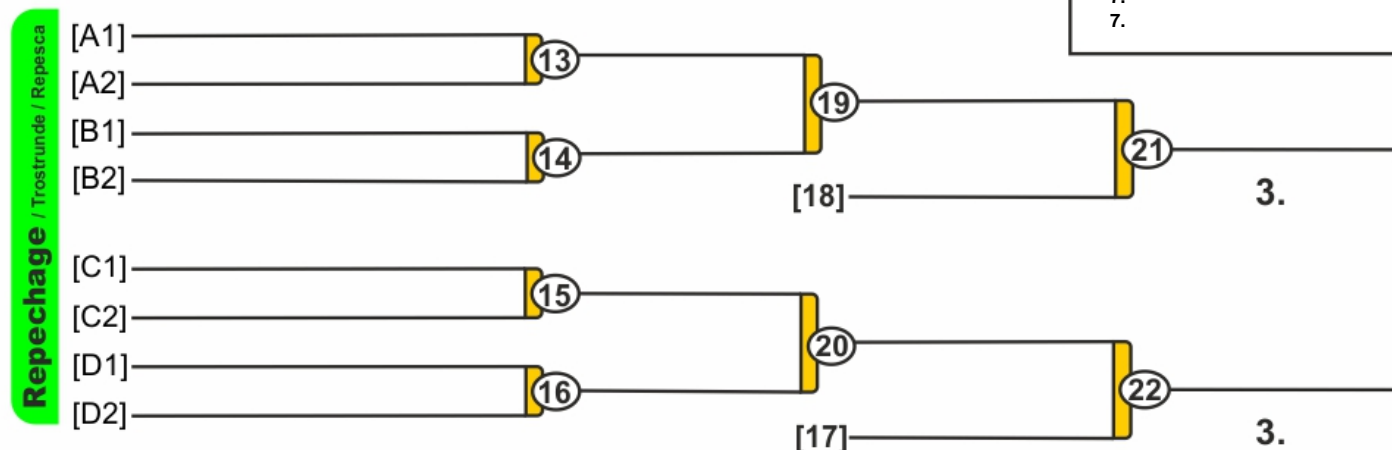

		1	2	3	4	
1	CASTANO SEBASTIAN, Tomas MAD					0 (0)
2	EL BEKKALI OUZZINE, Abd Hakim MAD					0 (0)
3	TRILLO VALEIRO, Sergio GAL					0 (0)
4	MARTIN GARCIA, Francisco CAN					0 (0)

1	CASTANO SEBASTIAN, Tomas MAD	1
2	EL BEKKALI OUZZINE, Abd Hakim MAD	

3	TRILLO VALEIRO, Sergio GAL	2
4	MARTIN GARCIA, Francisco CAN	

1	CASTANO SEBASTIAN, Tomas MAD	3
3	TRILLO VALEIRO, Sergio GAL	

2	EL BEKKALI OUZZINE, Abd Hakim MAD	4
4	MARTIN GARCIA, Francisco CAN	

1	CASTANO SEBASTIAN, Tomas MAD	5
4	MARTIN GARCIA, Francisco CAN	

2	EL BEKKALI OUZZINE, Abd Hakim MAD	6
3	TRILLO VALEIRO, Sergio GAL	

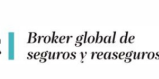

Final Results

- 1.
- 2.
- 3.



Copa A de España Absoluta Marin 2022

Marin (GAL), 02 Apr 2022

-48 kg

7 Judoka

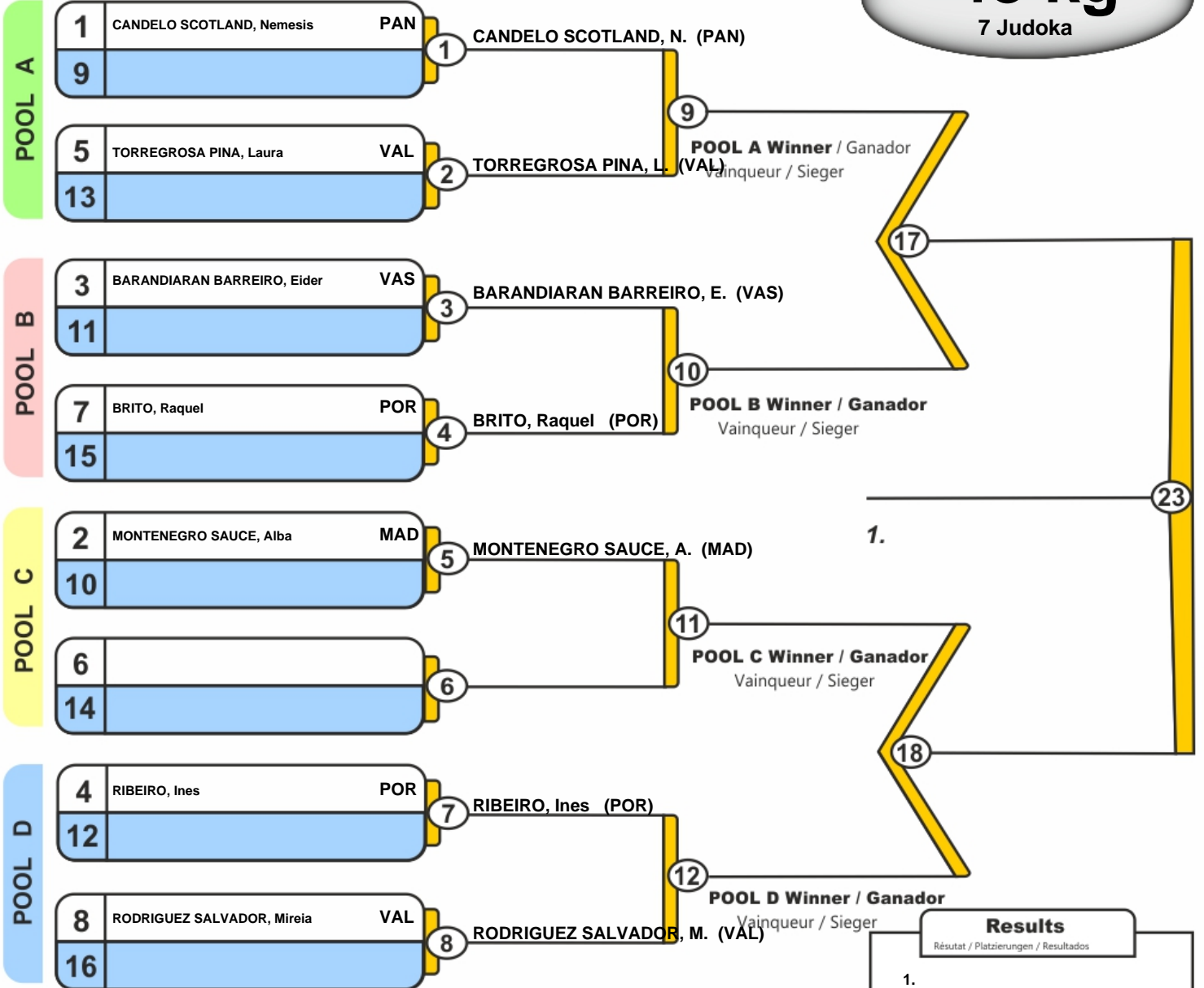

Trostrunde / Repechage / Ronda de consolación

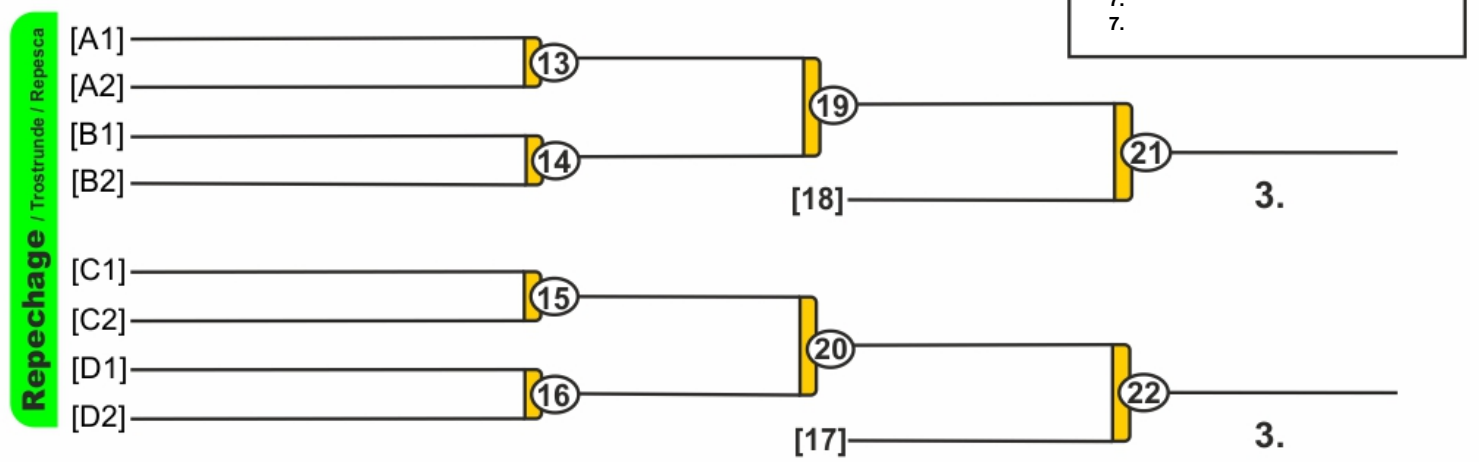

Results	
Résultat / Platzierungen / Resultados	
1.	
2.	
3.	
3.	
5.	
7.	
7.	



Copa A de Espana Absoluta Marin 2022

Marin (GAL), 02 Apr 2022

-52 kg

8 Judoka

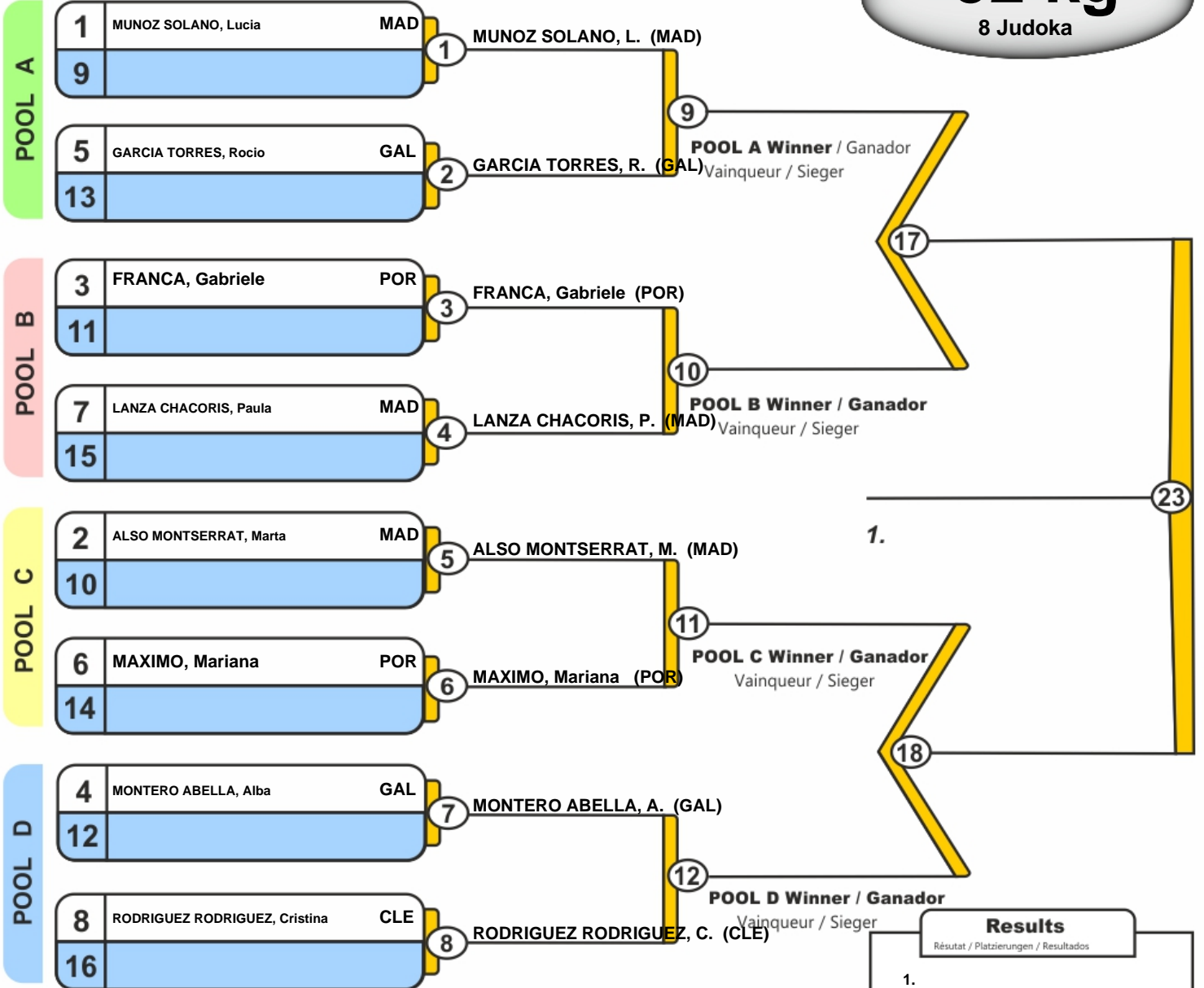

Trostrunde / Repechage / Ronda de consolación

Results	
Résultat / Platzierungen / Resultados	
1.	
2.	
3.	
3.	
5.	
7.	
7.	

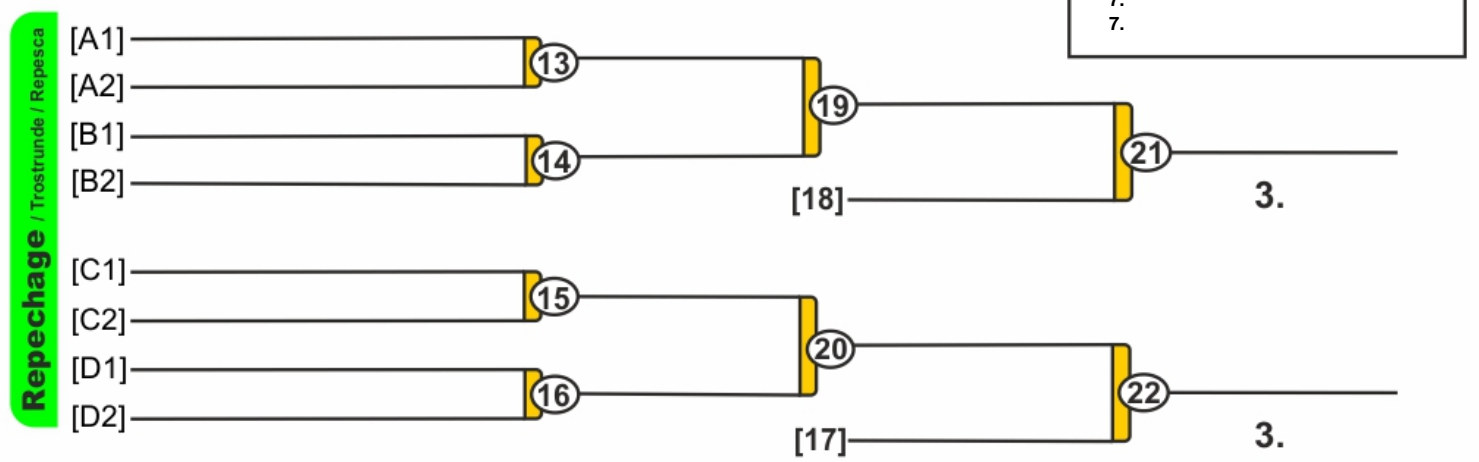

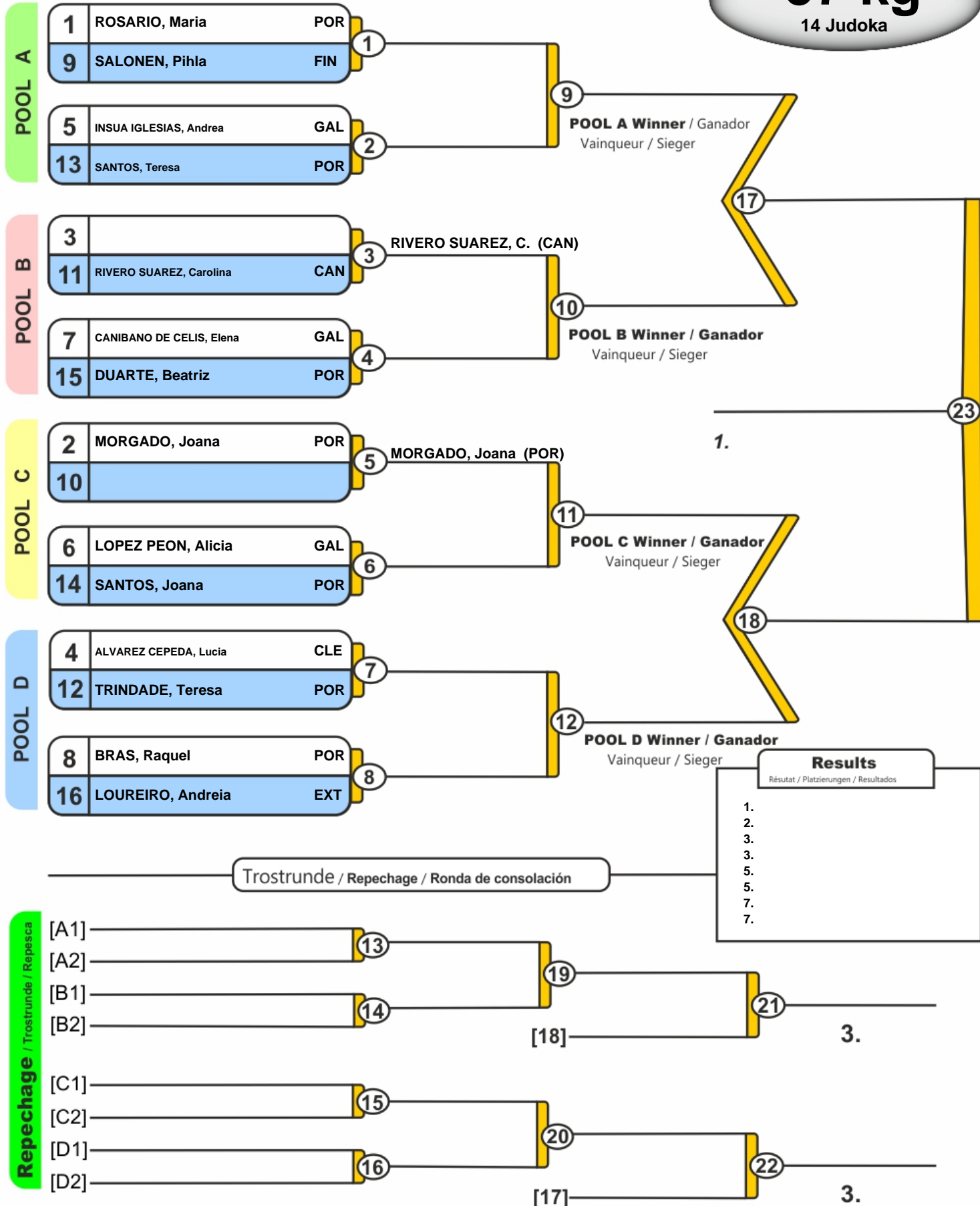



Copa A de Espana Absoluta Marin 2022

Marin (GAL), 02 Apr 2022

-63 kg

7 Judoka

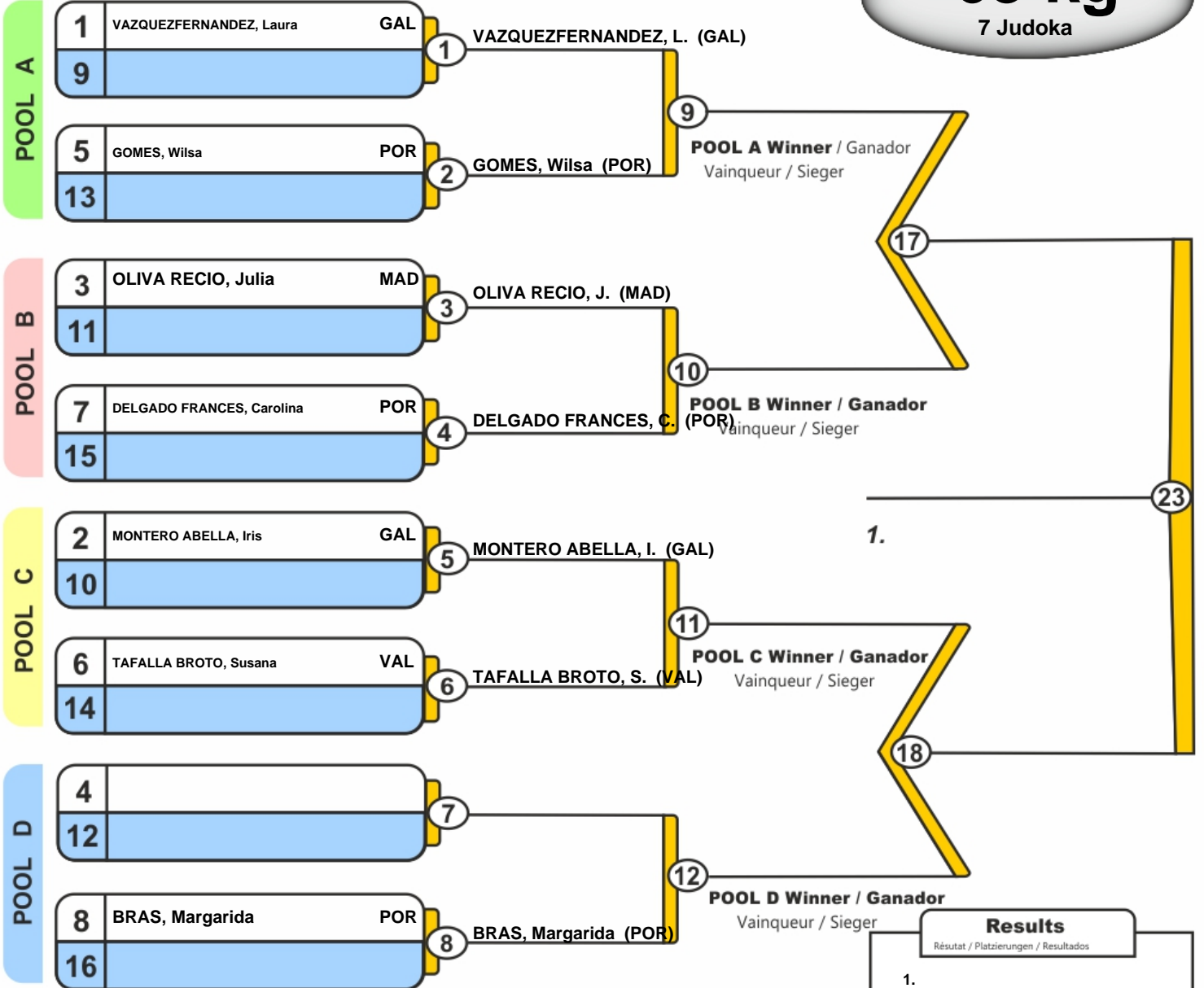

Trostrunde / Repechage / Ronda de consolación

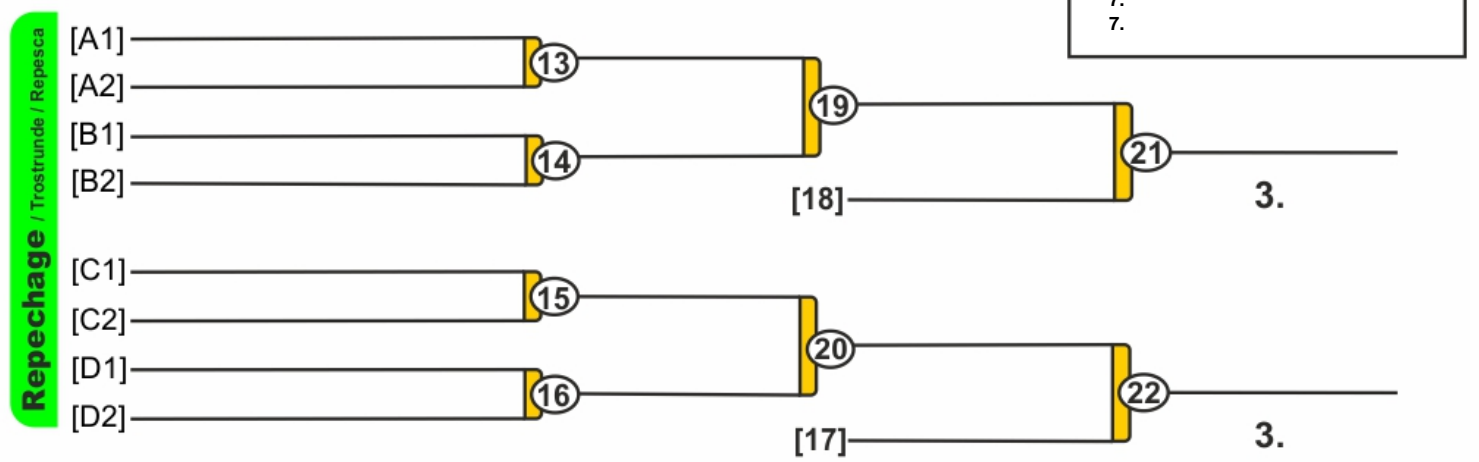

Results	
Résultat / Platzierungen / Resultados	
1.	
2.	
3.	
3.	
5.	
7.	
7.	

-70 kg
11 Judoka

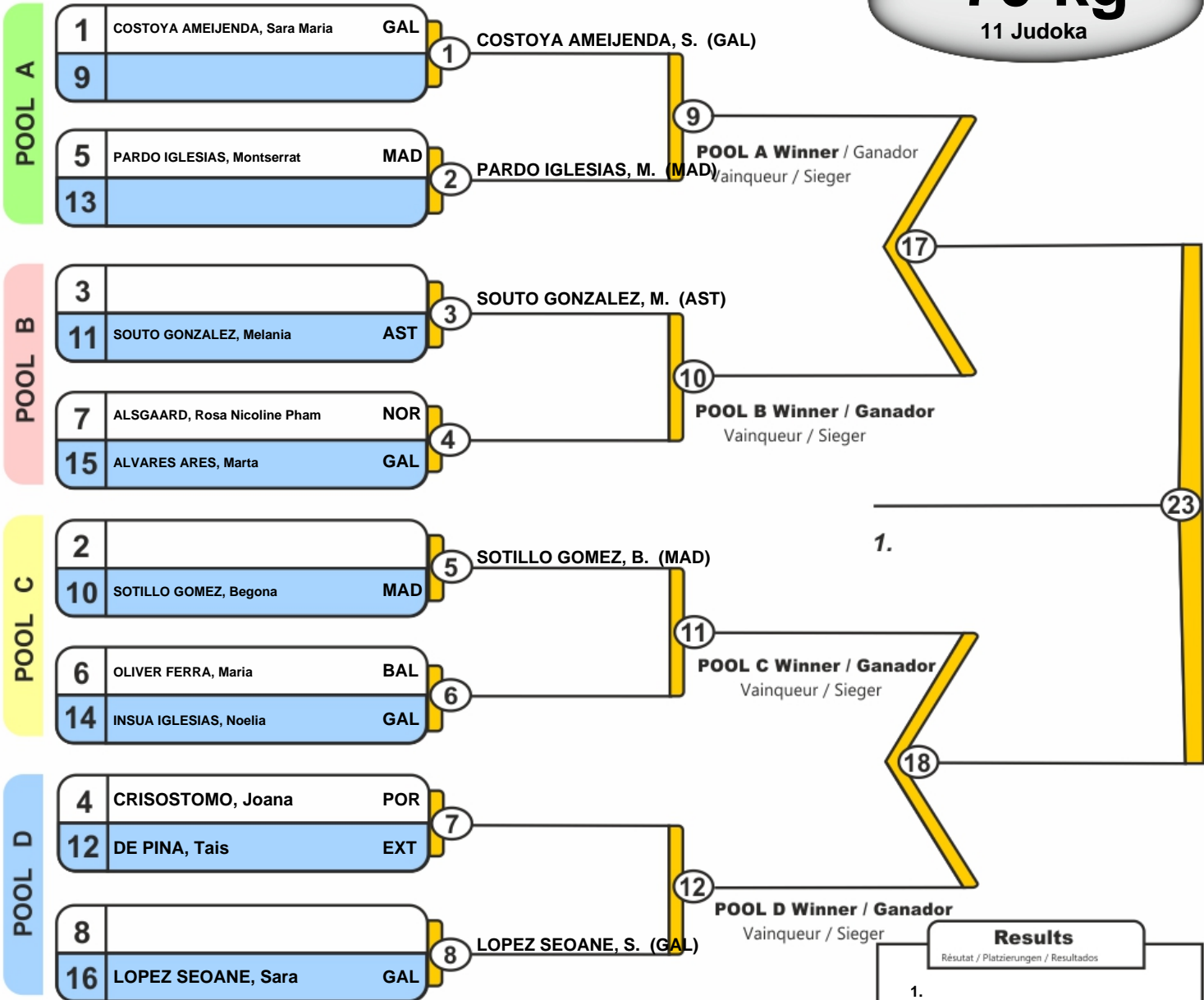

Trostrunde / Repechage / Ronda de consolación

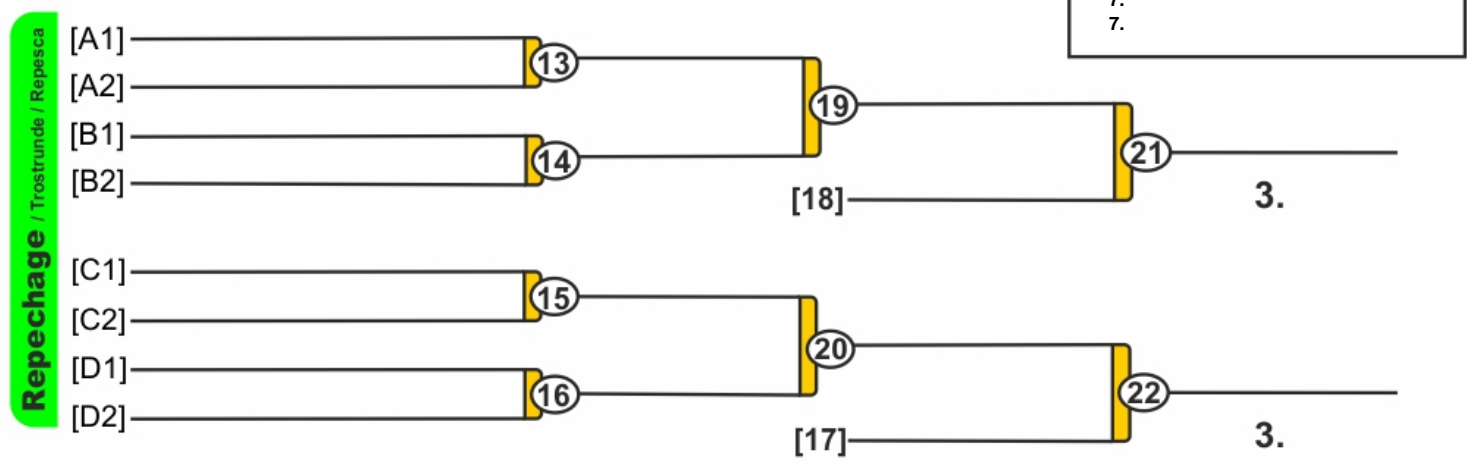

Results	
Résultat / Platzierungen / Resultados	
1.	
2.	
3.	
3.	
5.	
5.	
7.	
7.	

			1	2	3	4	
1	BRAVO SARABIA, Candela	MAD					0 (0)
2	MOREIRA, Beatriz	POR					0 (0)
3	CONCEICAO, Fabia	POR					0 (0)
4	BORDOLI LIMA, Iara Lucia	MAD					0 (0)

1	BRAVO SARABIA, Candela	MAD	1	
2	MOREIRA, Beatriz	POR		

3	CONCEICAO, Fabia	POR	2	
4	BORDOLI LIMA, Iara Lucia	MAD		

1	BRAVO SARABIA, Candela	MAD	3	
3	CONCEICAO, Fabia	POR		

2	MOREIRA, Beatriz	POR	4	
4	BORDOLI LIMA, Iara Lucia	MAD		

1	BRAVO SARABIA, Candela	MAD	5	
4	BORDOLI LIMA, Iara Lucia	MAD		

2	MOREIRA, Beatriz	POR	6	
3	CONCEICAO, Fabia	POR		

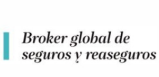

Final Results

- 1.
- 2.
- 3.



Copa A de Espana Absoluta Marin 2022

Marin (GAL), 02 Apr 2022

+78 kg
3 Judoka

			1	2	3	Wins Score
1	PENA PAIS, Yolanda	GAL				0 0
2	PIQUIN CASABELLA, Carla	GAL				0 0
3	SILVA, Ana	POR				0 0

1	PENA PAIS, Yolanda	GAL	①
2	PIQUIN CASABELLA, Carla	GAL	

1	PENA PAIS, Yolanda	GAL	②
3	SILVA, Ana	POR	

2	PIQUIN CASABELLA, Carla	GAL	③
3	SILVA, Ana	POR	

Final Results

- 1.
- 2.
- 3.